



Troffer (RC370 G5) Ver 2019

Sisesh Behuray & Yogesh Ganjewar
Professional Marketing, India
May 2019



Philips Troffer : *High on Specification & Efficacy*

Troffer 2019

The Surface of Light

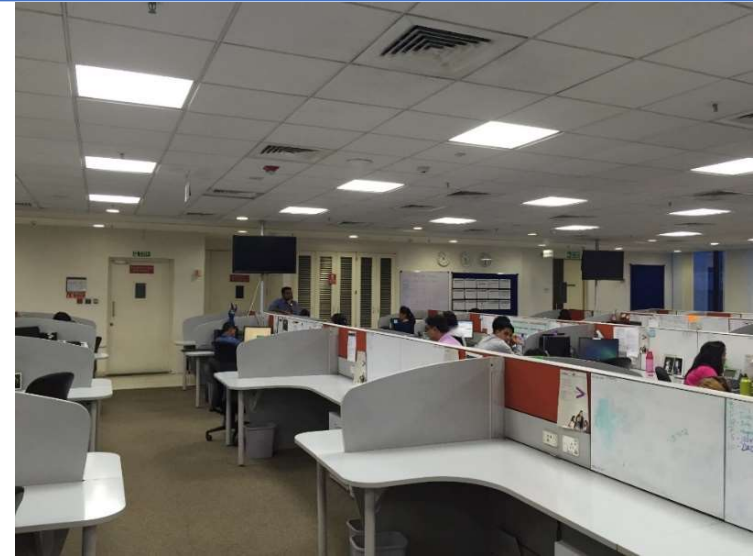
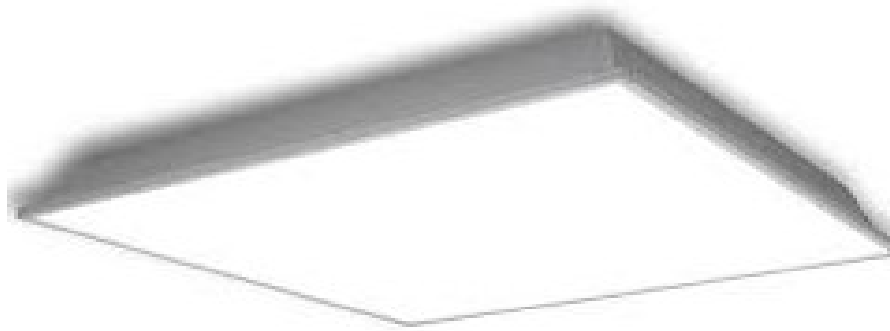

Features and Benefits

- Energy Efficient – High Efficacy of ≥ 120 Lm /W
- Comfortable Light – CRI of 80 to ensure better color rendering
- Lifetime : 25,000 Hrs., Reliable performance
- Optimal Lighting Effects : New light platform and optical design for glare free environment

Product Specifications

S No.	Description	RC370B G4
1	System Lumen	3000 Lm @ 24W & 3600 Lm @ 30W
2	CCT	6500K / 4000K
3	CRI	80
4	SDCM	<5
5	Efficacy	LED 30S : 125 Lm/W & LED 36S: 120Lm/W
6	Operating Temp	Ambient : 45 Degrees
7	IP rating/ IK	20/ 02
8	Diffuser	PS
9	Dimensions	595×595x 70 mm
10	Life	L70B50@ 25K Hrs.
11	Serviceability	Class B
12	LED	APT
13	Housing	CRCA
14	Look and Feel	Fully Diffused Luminaire
15	THD	<33%

Focus on general illumination applications

- Office
- Retail
- Healthcare
- Hospitality
- Showrooms

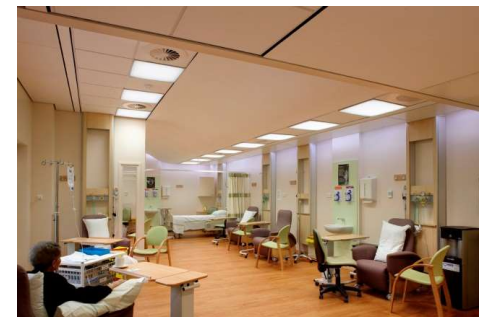

How to read the Cat ref



RC 370 B LED30S-6500 G5 L60W60 PSU OD

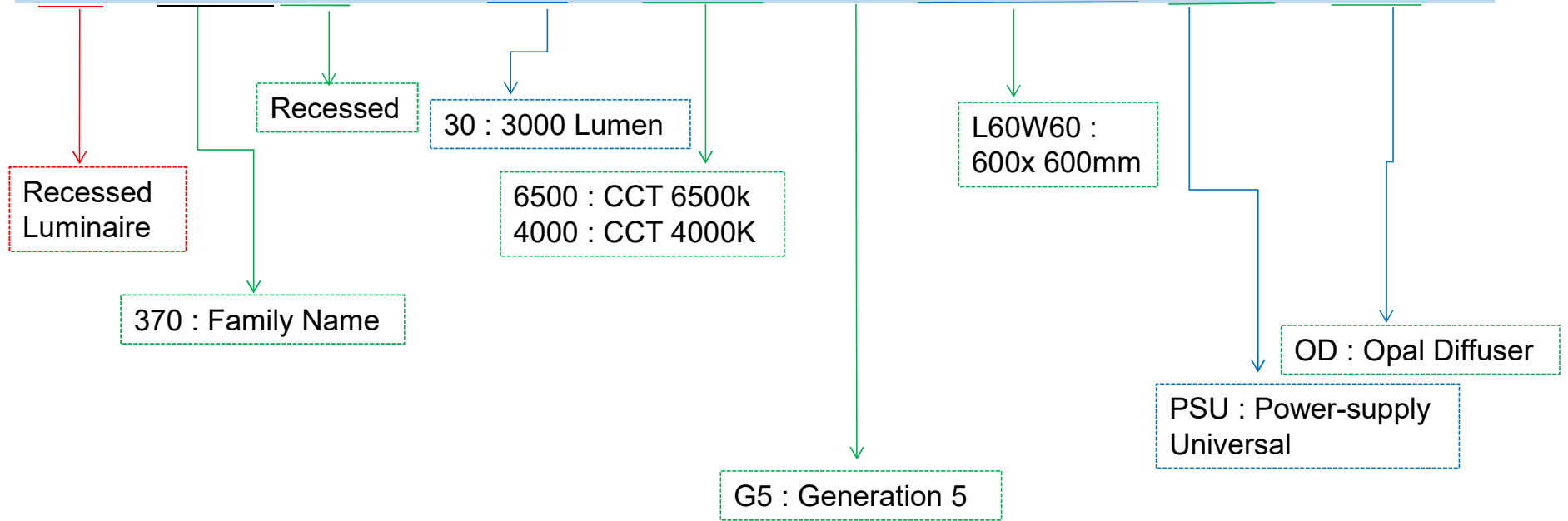

Ordering Codes:

S No.	12 NC	Description	Qty Per Box	Spare Driver 12 NC
1	919515813239	RC370B LED30S-4000 G5 L60W60 PSU OD	2	TBA
2	919515813240	RC370B LED30S-6500 G5 L60W60 PSU OD	2	TBA
3	919515813241	RC370B LED36S-4000 G5 L60W60 PSU OD	2	TBA
4	919515813242	RC370B LED36S-6500 G5 L60W60 PSU OD	2	TBA

Mounting Instructions

Only for any servicing work
Diffuser frame can be opened (but not recommended)

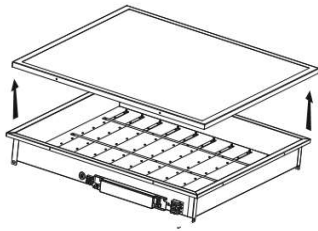

Remove 4 nos. screws from Diffuser Frame
to open the Fitting for access.

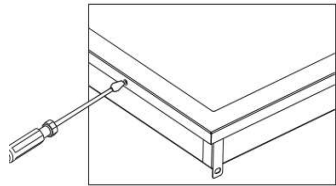

Unscrew to open
Diffuser Frame

Installation Instructions PHILIPS

FULL GLOW G4
Recessed



⊕ THIS LUMINAIRE MUST BE EARTHED

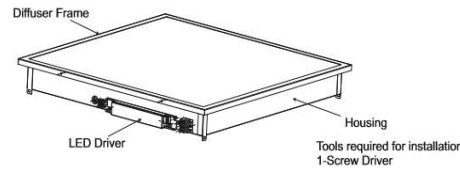

Product Dimensions

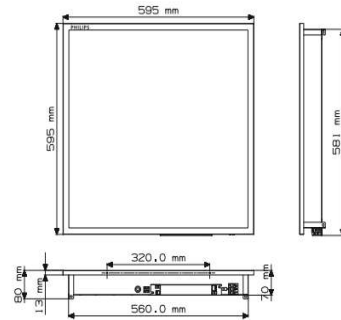

4413 100 2010

! ATTENTION: Install in accordance with national and local building and electrical codes.

PHILIPS

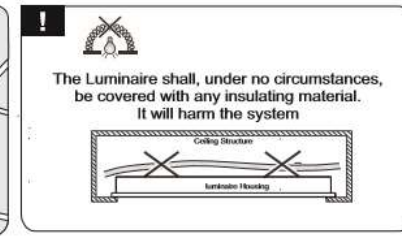
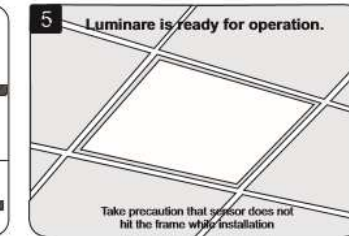
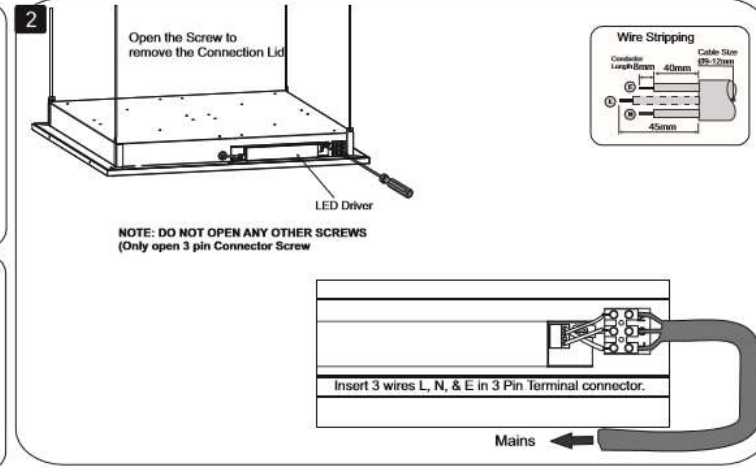
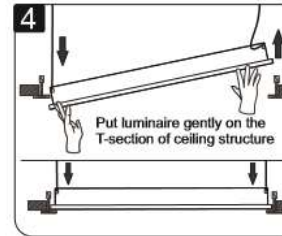
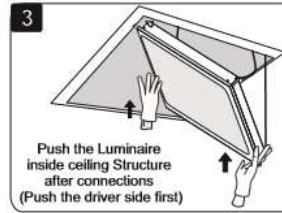
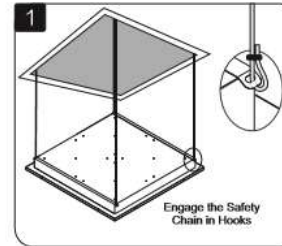

Phase in Phase out Information

Old 12NC	Old Product Description	New 12NC	New Product Description
919515812137	RC370B LED30S-6500 G4 L60 W60 PSU OD	919515813240	RC370B LED30S-6500 G5 L60W60 PSU OD
919515812153	RC370B LED30S-4000 G4 L60 W60 PSU OD	919515813239	RC370B LED30S-4000 G5 L60W60 PSU OD

